

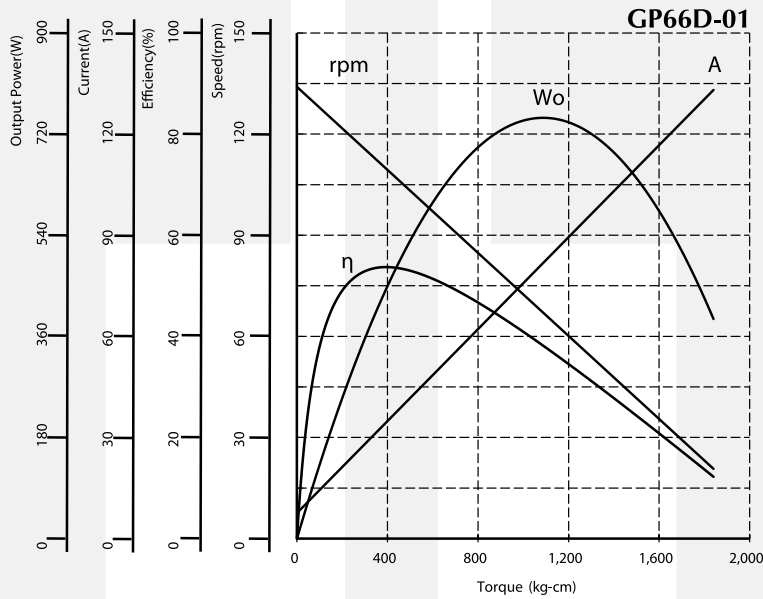

Hub Motor – GP66D-01 Series

Voltage : 24 - 48V DC
 Rated Speed : 120 - 140rpm
 Rated Output Power: 600 - 1,000W
 Gear Ratio : 18 : 1
 Rated Torque : 397.68kg-cm[345.17lb-in]
 Motor Diameter : Ø250mm[9.84inch]
 Typical Application : Scooter, Shopping Cart, Cleaning Cart, Sweeper

Performance Curve



Dimension (mm[inch])

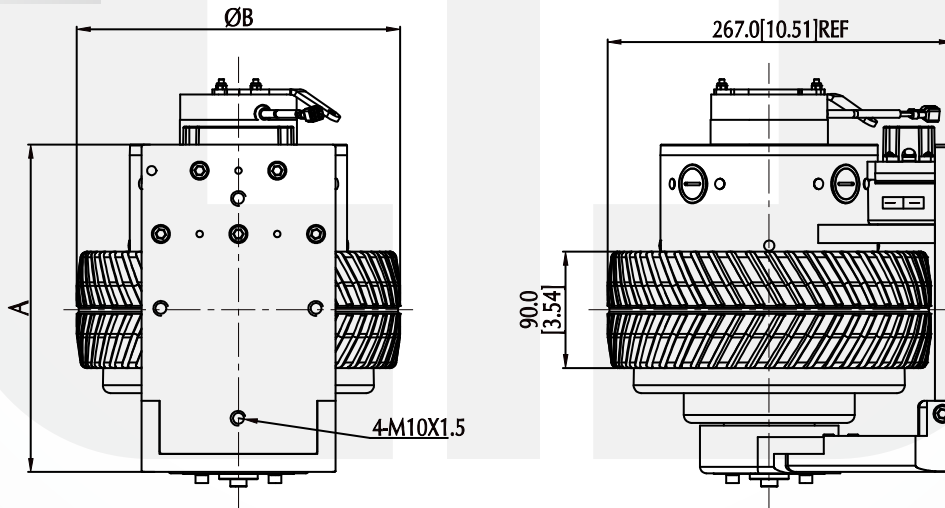

Performance (testing under room temperature)

Model	Dim A mm[inch]	Dim B mm[inch]	Gear Ratio	Rated Voltage (V DC)	No Load		At Maximum Efficiency					Max Power	
					Speed (rpm)	Current (A)	Torque (kg-cm[lb-in])	Speed (rpm)	Current (A)	Output (W)	Effic'y (%)	Torque (kg-cm[lb-in])	Current (A)
GP66D-01T-0001	253.0[9.96]	250.0[9.84]	18:1	36	135	5.50	397.68[345.17]	110	19.50	449.0	64.0	2,220.91[1,927.66]	83.6
GP66D-01T-0002	253.0[9.96]	250.0[9.84]	18:1	24	134	7.60	397.68[345.17]	110	34.71	447.3	53.70	2,176.04[1,888.72]	155.96

The information above is for reference only, detailed specification is subject to final confirmation

Email: sales@cclmotors.com Website: <http://www.cclmotors.com>
 5/F, No. 6, On Lok Mun Street, On Lok Tsuen, Fanling, N.T., Hong Kong.

Tel: (852) 3125 0000 Fax: (852) 3125 0125