

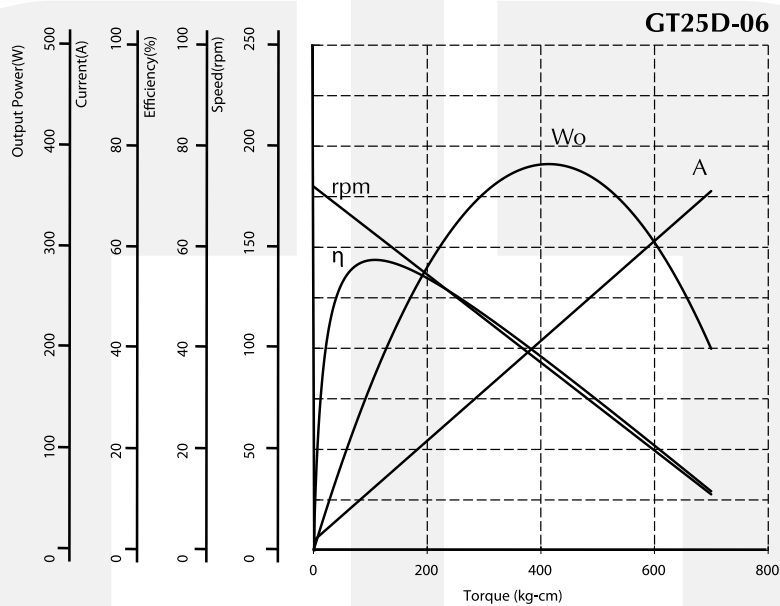

Transaxle - GT25D-06 Series

Voltage : 12 - 24V DC
 Rated Speed : 150 - 230rpm
 Rated Output Power: 100 - 300W
 Gear Ratio : 17.75 : 1
 Rated Torque : 82.1-113.4kg-cm[71.26-98.43lb-in]
 Loading Capability : 315.0kg-cm[273.41lb-in]
 Motor Diameter : Ø64.9mm[2.56inch]
 Typical Application : Scooter, Polisher
 Feature : Optional Break

Performance Curve



Dimension (mm[inch])

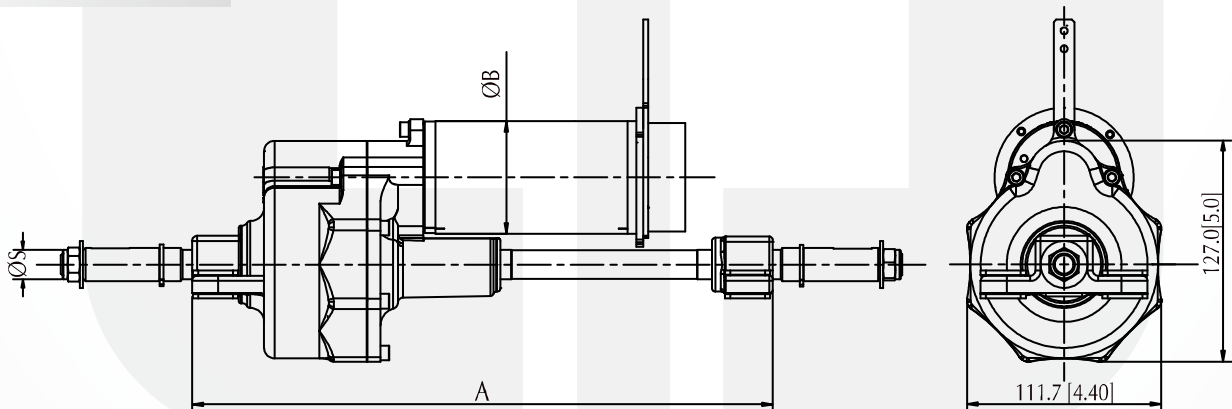

Performance (testing under room temperature)

Model	Dim A mm[inch]	Dim B mm[inch]	Dim S mm[inch]	Gear Ratio	Rated Voltage (VDC)	No Load		At Maximum Efficiency				Max Power		
						Speed (rpm)	Current (A)	Torque (kg-cm[lb-in])	Speed (rpm)	Current (A)	Output (W)	Effc'y (%)	Torque (kg-cm[lb-in])	Current (A)
GT25D-06-01	393.4[15.49]	64.9[2.56]	17[0.67]	17.75:1	24	195	2.0	82.1[71.26]	138	11.7	116.1	41.3	243.3[254.57]	36.7
GT25D-06-02	334.1[13.15]	64.9[2.56]	17[0.67]	17.75:1	24	210	2.0	113.4[98.43]	172	11.7	200.5	71.4	315.0[273.41]	28.1

The information above is for reference only, detailed specification is subject to final confirmation

Email: sales@cclmotors.com Website: <http://www.cclmotors.com>
5/F, No. 6, On Lok Mun Street, On Lok Tsuen, Fanling, N.T., Hong Kong.

Tel: (852) 3125 0000 Fax: (852) 3125 0125