

Universal Motor - UP Series

Voltage : 100 - 240V AC (50/60Hz)
 Rated Speed : 12,000 - 18,000rpm
 Rated Output Power: 80 - 360W
 Insulation Class : A, B, F
 Motor Diameter : Ø70mm[2.76inch]
 Typical Application : Blender, Juice Extractor, Food Processor, Meat Grinder,
 Drink Mixer, Grass Trimmer, Water Pump, Ice Chopper

Performance Curve

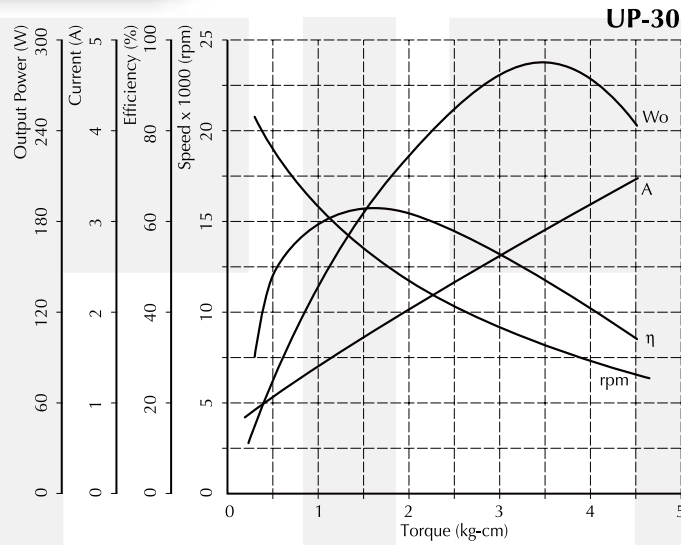

Dimension (mm[inch])

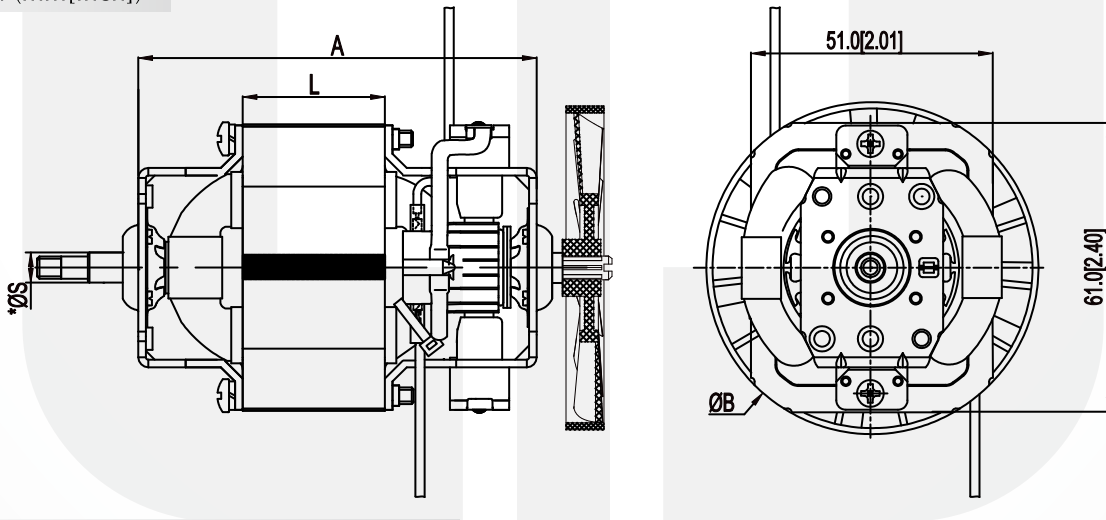

Performance (testing under room temperature)

Model	Dim A mm[inch]	Dim B mm[inch]	Dim L mm[inch]	Dim S mm[inch]	Rated Torque (kg-cm[lb-in])	Rated Output Power (W)
UP-15	69.0 [2.72]	70.0 [2.76]	15.0 [0.59]	6.35 - 8.0 [0.25 - 0.31]	0.6 - 2.0 [0.52 - 1.73]	80 - 165
UP-20	74.0 [2.91]	70.0 [2.76]	20.0 [0.79]	6.35 - 8.0 [0.25 - 0.31]	0.8 - 2.4 [0.69 - 2.08]	110 - 220
UP-25	79.0 [3.11]	70.0 [2.76]	25.0 [0.98]	6.35 - 8.0 [0.25 - 0.31]	1.0 - 3.0 [0.87 - 2.60]	135 - 250
UP-30	84.0 [3.31]	70.0 [2.76]	30.0 [1.18]	6.35 - 8.0 [0.25 - 0.31]	1.2 - 3.5 [1.04 - 3.03]	165 - 275
UP-35	89.0 [3.50]	70.0 [2.76]	35.0 [1.38]	6.35 - 8.0 [0.25 - 0.31]	1.5 - 4.0 [1.30 - 3.47]	220 - 300
UP-40	94.0 [3.70]	70.0 [2.76]	40.0 [1.38]	6.35 - 8.0 [0.25 - 0.31]	2.0 - 5.0 [1.73 - 4.34]	275 - 360

The information above is for reference only, detailed specification is subject to final confirmation

Email: sales@cclmotors.com Website: <http://www.cclmotors.com>
 5/F, No. 6, On Lok Mun Street, On Lok Tsuen, Fanling, N.T., Hong Kong.

Tel: (852) 3125 0000 Fax: (852) 3125 0125